

SECTION 15

Scyon™ and James Hardie® Products



PrimeLine® weatherboard and Scyon™ products 15.0

HardiPlank® weatherboard and HardiFlex® sheet 15.1

ExoTec® facade panel and fixing system 15.2

ComTex® facade panel and fixing system 15.2

Villaboard® lining 15.3

HardiPanel® compressed sheet 15.3

HardiBrace® sheet 15.4

Artista® column 15.4

General Accessories 15.5

Cladding



An exterior cladding system with a geometric, expressed-jointed look. Fast and simple to install, it creates the commercial look without the price tag. For residential and medium-density applications.



A vertically grooved cladding panel that looks sharp and smooth. Pre-primed and easy to install, it creates a pristine look that lasts. For residential applications.

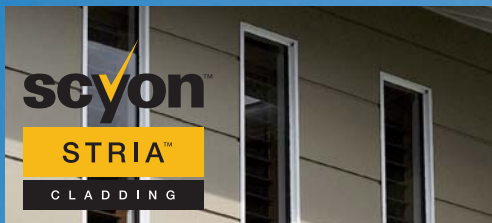

A wide cladding board, with a 15mm horizontal joint, that has the classic appeal of decorative render. Pre-primed and easy to install, it is the fast way to achieve a timeless look. For residential applications.



A 16mm thick horizontal weatherboard, with deep shadow lines, that has the look of traditional weatherboard without weathering like one. For residential applications.

The finishing touch



A thick and versatile trim that's the easy way to add finishing touches that keep their finish. For window edge treatments, finishing touches to internal and external corners, and a durable batten over butt joints.

Flooring



A heavy-duty but lightweight structural flooring substrate that does double duty – it can be easily used for tile, vinyl and carpet finishes over timber or steel floor joists in both residential general interiors and wet areas as an alternative to particleboard, plywood or compressed fibre cement. Simple and fast to install, it's the easiest way to get top protection against moisture damage in all interior floors.



An external structural flooring substrate for tile finishes over timber or lightweight steel floor joists. Simple and fast to install, it helps give you peace of mind against moisture damage to balconies. For tiled residential balconies.

* When installed and maintained correctly and to the extent set out in James Hardie's published literature current at the time of installation. Can be gun nailed for face fixing only.

Scyon™ is the advanced lightweight cement composite with the heavy-duty performance. Not only is it resistant to damage from termites, rot and fire,* but it can also be gun nailed and is easy to cut – like timber.

Visit www.scyon.com.au for more details



Look at LINEA™

SCYON™ LINEA™ WEATHERBOARD,
THE WEATHERBOARD THAT DOESN'T WEATHER

www.scyon.com.au



LOOK AT FINLAYSON'S

This 16mm thick horizontal weatherboard has the shadow lines of a traditional weatherboard without the weathering. Unlike some timber, Linea weatherboard will resist shrinking, swelling and cracking* to hold paint longer than wood, and can also be painted dark as well as light colours. There's also a 15-year paint warranty when painting Wattyl Solagard® or Taubmans All Weather® and Sun Proof Max® on Linea weatherboard.

**When installed and maintained correctly.*

135 Wellington Road East Brisbane Queensland 4169

Phone: 07 3393 0588

Email: info@finlayson.com.au



SCYON™ STRIA™ CLADDING DELIVERS A ROBUST YET
REFINED FLAVOUR TO YOUR HOME

Look at STRIA™

www.scyon.com.au



LOOK AT FINLAYSON'S

Faster than laying bricks, rendering, scoring and painting (with all the associated mess and scheduling of different trades), Stria™ cladding is the simple, speedy way to get a classic but modern look. With a shiplapped joint on the extra-wide board it can easily be concealed or face fixed and joined on or off stud. There's also a 15-year paint warranty on when painting Stria™ cladding with Watty Solagard®.

135 Wellington Road East Brisbane Queensland 4169
Phone: 07 3393 0588 Email: info@finlayson.com.au



Look at AXON™

SCYON™ AXON™ CLADDING, FOR
A CRISP LOOK DESIGNED TO LAST



LOOK AT FINLAYSON'S

The stepped shiplap on the long edges of Axon™ cladding means sheets are easily installed. Paint application is fast because the pre-primed sheets mean less paint and time is needed to achieve a high-quality finish. Made from Scyon™, it will resist shrinking, swelling and cracking* to hold paint longer than wood, and can therefore be painted dark as well as light colours.

**When installed and maintained correctly.*

135 Wellington Road East Brisbane Queensland 4169
Phone: 07 3393 0588



SCYON™ MATRIX™ CLADDING, THE QUINTESSENTIAL
UNDERSTATEMENT OF SOPHISTICATED LIVING

Look at MATRIX™

www.scyon.com.au

LOOK AT FINLAYSON'S

Instead of needing the steel top hats associated with many commercial systems, Matrix cladding sheets are installed with Scyon™ cavity trim battens. The expressed joint is created easily using a 10mm packer. Sheets are sanded smooth and pre-primed for fast paint application and a high-quality finish. Matrix cladding's resistance to cracking, warping and swelling* means it can be painted both dark and light colours.

**When installed and maintained correctly.*

135 Wellington Road East Brisbane Queensland 4169

Phone: 07 3393 0588

Email: info@finlayson.com.au

scyon™

MATRIX™

CLADDING



Look at SECURA™

SCYON™ SECURA™ EXTERIOR FLOORING
HELPS YOUR BALCONY SUBSTRATE REMAIN
STRUCTURALLY SOUND AGAINST THE ELEMENTS

www.scyon.com.au

LOOK AT FINLAYSON'S

At about 40kg and 2,700mm long by 600mm wide, the tongue and grooved Secura™ exterior flooring is about 20% lighter than compressed sheet (per square metre). Sealed on all sides with an advanced polymer coating that helps protect the board from moisture-related problems, the mesh reinforcement on the underside enhances the heavy-duty performance of Scyon™, the heavy-duty lightweight from James Hardie.

135 Wellington Road East Brisbane Queensland 4169

Phone: 07 3393 0588

Email: info@finlayson.com.au



SECURA™ EXTERIOR FLOORING

What is it?

An external structural flooring substrate for ceramic tile finishes over timber or lightweight steel floor joists. Simple and fast to install, Scyon™ Secura™ exterior flooring helps give you peace of mind against moisture damage to balconies.

Where do you use it?

As an external substrate for tiled residential balconies and as an alternative to particleboard, plywood or compressed fibre cement.

WHAT ARE THE KEY BENEFITS?

SECURITY. Secura external flooring is sealed on all sides with an advanced polymer coating that helps protect the board from moisture-related problems. A topcoat on the surface of the board provides good adhesion. The mesh reinforcement on the underside enhances the heavy-duty performance of the Scyon™ material, adding extra strength and impact resistance to deliver a suitable external residential flooring substrate.

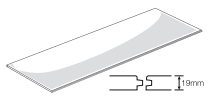

EASY TO INSTALL. At about 40kg and 2,700mm long by 600mm wide, Secura exterior flooring is about 20% lighter than compressed sheet (per square meter) and can be carried by two people, tucked under the arm and carried like a large surfboard. It's also tongued and grooved, which delivers engineered joints and eliminates the need for timber trimmers under these joints.

SPEED. For balconies that aren't over habitable rooms - verandas for example - no additional waterproofing membrane is needed once Secura exterior flooring is installed. For balconies over habitable rooms, a waterproofing system needs to be applied.

Secura exterior flooring	
Product	Description
	Size: 19 x 600 x 2,700mm Approx. mass: 40kg

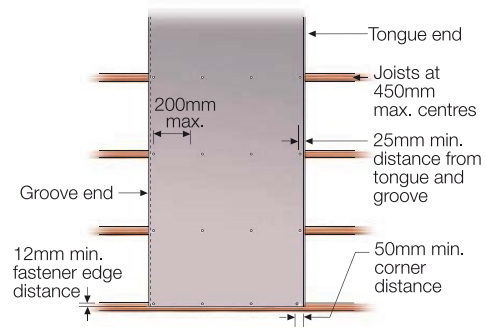
Secura exterior flooring fastener layout

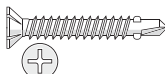

Accessories	Description
	James Hardie Joint Sealant Polyurethane joint sealant for sealing of all sheet joints. PC: 300753
	HardiBlade® Saw Blade Ø185 poly diamond blade, for fast, clean cutting of Secura exterior flooring. PC: 300660
	HardiDrive® Screw For fastening to 0.75mm - 1.6mm BMT steel frames. Class 3 finish. Length 40mm. PC: 300635

COMPONENTS NOT SUPPLIED BY JAMES HARDIE	
Accessories	Description
	Nails 50 x 2.8mm corrosion-resistant fibre cement nails. 50mm corrosion-resistant D Head gun nails.

For more information about performance, installation, warranties and warnings: www.scyon.com.au

Ask James Hardie™
Call 13 11 03
www.jameshardie.com.au

© 2007 James Hardie Australia Pty Ltd.™ and ® denote a trademark or registered mark owned by James Hardie International Finance BV.



Look at **SECURA**TM

TOP PROTECTION AGAINST MOISTURE DAMAGE
IN ALL INTERIOR FLOORS

www.scyon.com.au



LOOK AT FINLAYSON'S

Able to be gun-nailed, cut like timber, with a tongue and grooved joint and 15% less weight than conventional 15mm compressed*, SecuraTM interior flooring can also be up to 40% faster to install. Tiles and vinyl can be directly fixed without an underlay sheet and a sealer on all sides boosts the moisture-resistant properties of the ScyonTM material for top protection in all interior floors, including wet areas.

**Per square metre.*

135 Wellington Road East Brisbane Queensland 4169

Phone: 07 3393 0588

Email: info@finlayson.com.au

Richmond Remodel. Architect Ed Ewers from Ed Ewers Architecture entered this renovation of an 1880's cottage in the Look Green Home Design Awards. It features Scyon™ Matrix™ cladding.



RICHMOND REMODEL

LOCATION: Richmond, Victoria.

ARCHITECT: Ed Ewers from Ed Ewers Architecture

GREEN POINTS: Water conservation includes 2500L rainwater tank plumbed to cistern and grey water recycling system. Improved thermal insulation with a double cavity insulated west wall. Lightweight construction including Scyon™ Matrix™ cladding used externally. Recycled timber flooring.



Ask James Hardie™
Call 13 11 03
www.jameshardie.com.au

JAMES HARDIE®

Scyon™ and James Hardie® Products

15.0 SCYON™ | PRIMELINE®

SCYON™ AXON™ CLADDING (9mm) and ACCESSORIES		
403931	2450 x 1200	\$89.36
403932	2750 x 1200	\$100.30
403933	3000 x 1200	\$109.42
304560	50 mm foam back sealing tape 25m roll	\$65.67
300917	JH aluminium snap on corner (2piece) 3m	\$65.09
SCYON™ MATRIX™ CLADDING (8mm) and ACCESSORIES		
403810	Matrix Panel 2390 x 590	\$36.91
403811	Matrix Panel 1190 x 1190	\$37.06
403812	Matrix Panel 1790 x 890	\$41.71
404169	Matrix Panel 2990 x 1190	\$98.12
304530	JH 18mmpvc cavity vent strip 3m	\$7.44
300560	JH backing strip 1190mm	\$3.96
300561	JH backing strip 2390mm	\$7.96
300562	JH backing strip 2290mm	\$9.97
302761	JH facade washer box of 100	\$68.18
SCYON™ LINEA™ WEATHERBOARD (16mm) and ACCESSORIES		
403912	4200 x 180	\$31.87
403930	4200 x 150	\$25.62
304352	Linea alum ext slim box corner 3.6mm	\$86.27
304351	linea alum int corner mould 3.6mm	\$43.75
301203	linea pvc box cnr z flashing 2.7m	\$12.25
302632	linea pvc starter strip 3m	\$11.70
301186	linea 180mm alum cnr soaker 90o	\$2.82
301197	linea 180mm ss cnr soaker 90o	\$3.99
302820	linea 150mm alum cnr soaker 90o	\$2.74
302821	linea 150mm ss cnr soaker 90o	\$3.59
304350	linea alum uni window adaptor 3.7m	\$37.33
SCYON™ STRIA™ CLADDING (14mm) and ACCESSORIES		
404063	4200 x 325	\$66.63
304771	Stria Vertical Flashing Stop 3.0m	\$20.54
304871	Stria Aluminium Internal Corner 3.0m	\$35.74
304872	Stria Aluminium External Box corner 3.0m	\$46.30
304891	James Hardie Corner Flashing 75x75 3.0m	\$23.73
SCYON™ ACCENT™ TRIM		
403625	Trim 4200 x 84 (38mm)	\$45.36
403626	Trim 4200 x 45 (38mm)	\$27.39
403934	Trim 2600 x 84 (16mm)	\$16.35
403935	Trim 2600 x 100 (16mm)	\$19.27
403840	Scyon cavity trim 2450 x 70 (19mm)	\$15.84
SCYON™ SECURA™ INTERIOR FLOORING (19mm)		
404173	2700 x 600	\$100.75
SCYON™ SECURA™ EXTERIOR FLOORING (19mm)		
404050	2700 x 600	\$117.02

PRIMELINE® WEATHERBOARD (9mm) PRE-PRIMED & ACCESSORIES		
400103	Chamfer- 4200 x 300	\$39.24
400153	Heritage- 4200 x 300	\$37.43
400319	Newport - 4200 x 170	\$23.71
400380	Summit - 4200 x 230	\$32.87
300974	Primeline Universal off stud joint clip pkt of 100	\$44.03
300917	JH Aluminium Snap On corner (2Piece) 3m	\$65.09
302633	JH 7.5mm PVC Starter Strip 3m	\$12.21

15.1 HARDIPLANK® | HARDIFLEX®

HARDIPLANK® WEATHERBOARD (7.5mm) and ACCESSORIES		
400265	Smooth - 4200 x 230	\$17.47
400266	Smooth - 4200 x 300	\$24.71
403080	Woodgrain - 4200 x 230	\$21.91
403081	Woodgrain - 4200 x 300	\$30.77
400371	Old Style - 4200 x 205	\$23.84
400378	Rusticated -4200 x 205	\$24.27
300760	Hardiplank stud clips pkt of 100	\$37.15
300671	Hardiplank zincalume footmould 3m	\$21.88
300879	Hardiplank smooth pvc joint 230mm pkt 25	\$13.93
300880	Hardiplank smooth pvc joint 300mm pkt 25	\$18.29
300882	Hardiplank woodgrain pvc joint 230mm pkt 25	\$15.95
300883	Hardiplankwoodgrainpvc joint 300mm pkt 25	\$19.86
300665	Hardiplank alum ext corner angle 230mm (100)	\$142.26
300666	Hardiplank alum ext corner angle 300mm (100)	\$148.14
300722	Hardiplank alum int corner angle 230mm (100)	\$145.88
300723	Hardiplank alum int corner angle 300mm (100)	\$167.17
300742	Metal Soaker joiner 205mm pkt of 25	\$28.91
300740	Metal Soaker joiner 230mm pkt of 25	\$31.02
300741	Metal Soaker joiner 300mm pkt of25	\$36.85
HARDIFLEX® SHEET 4.5mm		
400195	1800 x 900	\$15.98
400193	2400 x 900	\$21.30
400192	2700 x 900	\$23.97
400191	3000 x 900	\$26.62
400189	1800 x 1200	\$21.30
400188	2100 x 1200	\$24.85
400186	2400 x 1200	\$28.40
400184	2700 x 1200	\$31.96
400182	3000 x 1200	\$35.50
HARDIFLEX® SHEET 6.0mm		
400175	2400 x 900	\$32.31
401970	3000 x 900	\$40.39
400173	1800 x 1200	\$32.31
400171	2400 x 1200	\$43.08
400169	2700 x 1200	\$47.47
400167	3000 x 1200	\$53.86
PANELCLAD® SHEET 6mm and ACCESSORIES		
400404	Stucco - 2440 x 1200	\$58.18
400403	Stucco - 3000 x 1200	\$71.54
400416	Textureline - 2440 x 1198	\$67.97
400417	Textureline - 2700 x 1198	\$74.89
300828	Textureline PVC straight joint 2.7mm	\$3.85
HARDITEX® BASE SHEET 7.5mm and ACCESSORIES		
400293	2440 x 900	\$30.40
400295	2725 x 900	\$33.96
400296	3000 x 900	\$37.38
401651	2440 x 1200	\$40.54
400294	2725 x 1200	\$45.27
400291	3000 x 1200	\$49.83
302633	JH 7.5mm PVC Starter Strip 3m	\$12.21
302634	Harditex PVC Z - Flashing 3m	\$9.49

JAMES HARDIE®

Scyon™ and James Hardie® Products

15.2 EXOTEC® | COMTEX®

HARDIFLEX® SHEET 4.5mm IN EAVES LINING SIZES (4.5mm)		
400393	2400 x 450	\$10.65
400392	2400 x 600	\$14.21
400391	2400 x 750	\$17.75
EXOTEC® FACADE PANEL (6mm)		
402703	2400 x1200	\$105.52
402706	3000 x1200	\$131.88
EXOTEC® FACADE PANEL (9mm)		
402220	1800 x 900	\$69.49
402204	2400 x 900	\$92.64
402208	3000 x 900	\$115.81
402201	1800 x 1200	\$93.98
402203	2100 x 1200	\$108.09
402205	2400 x 1200	\$123.51
402207	2700 x 1200	\$138.96
402209	3000 x 1200	\$154.40
EXOTEC® FACADE PANEL (12mm)		
402333	2400 x 1200	\$186.39
402334	3000 x 1200	\$227.37
EXOTEC® FIXING SYSTEM		
300560	JH Backing Strip 1190mm	\$3.96
300561	JH Backing Strip 2390mm	\$7.96
300562	JH Backing Strip 2990mm	\$9.96
300565	Exotec gasket snap strip 3.62m	\$17.41
304572	Exotec Top Hat section 6m	\$67.72
300571	Exotec Top hat section 7.2m	\$81.27
302701	Intermediate JH top hat 6m	\$45.87
302700	Intermediate JH top hat 7.2m	\$55.04
302761	JH facade washer box of 1000	\$68.18
COMTEX® FACADE PANEL (9mm) and FIXING SYSTEM		
400144	2400 x 1200	\$99.40
400143	3000 x 1200	\$124.25
304571	Comtex 9mm pvc starter strip 3.6m	\$11.43
304573	Comtex top hat 6m	\$53.57
302701	Intermediate JH top hat 6m	\$45.87
302700	Intermediate JH top hat 7.2m	\$55.04
302701	Intermediate JH top hat 6m	\$45.87
VILLABOARD® LINING (6mm)		
400367	2400 x 900	\$21.73
400366	3000 x 900	\$27.15
400364	1800 x 1200	\$21.73
400362	2400 x 1200	\$28.95
400361	2700 x 1200	\$32.56
400360	3000 x 1200	\$36.19
400359	3600 x 1200	\$43.42
400358	4200 x 1200	\$50.67
400370	2400 x 1350	\$32.56
400369	3000 x 1350	\$40.72
400368	3600 x 1350	\$48.84
400363	4200 x 1350	\$56.98
VILLABOARD LINING (9mm)		
400357	2400 x 1200	\$52.02
400356	2700 x 1200	\$58.54

15.3 VILLABOARD® | HARDIPANEL®

VILLABOARD® LINING (9mm)		
400355	3000 x 1200	\$65.04
400354	3600 x 1200	\$78.05
400331	3000 x 1350	\$73.15
VILLABOARD® LINING (12mm)		
400352	3000 x 1200	\$93.92
VERSILUX® LINING (4.5mm)		
400454	2400 x 900	\$27.18
401898	3600 x 900	\$40.77
400452	2400 x 1200	\$36.24
400451	2700 x 1200	\$40.77
400450	3000 x 1200	\$45.30
400449	3600 x 1200	\$54.36
VERSILUX® LINING (6mm)		
400425	3000 x 900	\$40.90
400424	2400 x 1200	\$43.62
400423	2700 x 1200	\$49.08
400422	3000 x 1200	\$54.53
400421	3600 x 1200	\$65.44
VERSILUX® LINING (9mm)		
401878	2700 x 1200	\$67.74
PINERIDGE® LINING (6mm) and ACCESSORIES		
400373	2540 x 1198	\$36.28
400372	2700 x 1198	\$38.57
300877	Pine Ridge pvc joiner	\$3.52
HARDIGROOVE® LINING (7.5mm)		
400245	2700 x 1200	\$89.21
HARDIPANEL® COMPRESSED SHEET (15mm)		
400090	1500 x 900	\$84.04
400089	1800 x 900	\$95.15
400088	2100 x 900	\$117.68
400087	2400 x 900	\$126.87
400086	2700 x 900	\$151.29
400085	3000 x 900	\$168.11
400084	1500 x 1200	\$112.07
400083	1800 x 1200	\$126.87
400082	2100 x 1200	\$156.90
400081	2400 x 1200	\$169.16
400080	2700 x 1200	\$201.72
400079	3000 x 1200	\$224.15
HARDIPANEL® COMPRESSED SHEET (18mm)		
400101	1500 x 900	\$95.91
400100	1800 x 900	\$108.56
400099	2400 x 900	\$144.75
400098	3000 x 900	\$191.80
400097	1500 x 1200	\$127.86
400096	1800 x 1200	\$144.75
400095	2100 x 1200	\$179.01
400094	2400 x 1200	\$193.02
400060	3000 x 1200	\$255.73
HARDIPANEL COMPRESSED SHEETS (24mm)		
400461	2400 x 1200	\$291.89

15.4 HARDIBRACE® | ARTISTA®

UNDERLAY SHEETS		
403190	Ceramic Tile Underlay 6mm - 1800 x 1200	\$28.52
400459	Vinyl and Cork Underlay 5mm - 1200 x 900	\$14.18
HARDIBRACE® SHEET BRACING (5mm)		
400159	2440 x 925	\$19.70
400158	2725 x 925	\$22.00
400157	2400 x 1225	\$26.08
400156	2725 x 1225	\$29.12
HARDISCREEN® LATTICE (6mm)		
400256	Diamond 2400 x 900	\$61.27
400254	Diamond 2400 x 1200	\$81.70
400260	Square 2400 x 900	\$61.27
400258	Square 2400 x 1200	\$81.70
EXOTEC® FACADE PANEL (12mm)		
402333	2400 x 1200	\$186.39
402334	3000 x 1200	\$227.37
ARTISTA® CLASSIC COLUMNS		
402874	195mm x 2.75m	\$171.27
402873	195mm x 4m	\$221.73
402876	250mm x 2.75m	\$210.52
402875	250mm x 4m	\$272.44
400552	345mm x 2.75m	\$323.44
400550	345mm x 4m	\$418.62
400593	425mm x 2.75m	\$454.19
400591	425mm x 4m	\$587.77
ARTISTA® TAPERED COLUMNS		
402882	250 to 195mm x 2.75	\$229.27
402912	345 to 250mm x 2.75	\$459.83
ARTISTA® COLUMNS CAPITALS, BASES & ACCESSORIES		
402867	195mm bell	\$61.88
402868	195mm cove	\$61.88
402866	195mm ornate	\$101.81
402865	195mm pencil round	\$55.74
402850	195mm quad	\$38.21
402860	195mm twin	\$71.49
402871	250mm bell	\$65.41
402872	250mm cove	\$70.72
402851	250mm ornate	\$112.45
402870	250mm pencil round	\$59.02
402852	250mm quad	\$40.00
402869	250mm twin	\$74.40
400570	345mm ornate	\$137.64
400572	345mm pencil round	\$68.19
400611	425mm ornate	\$267.29
400613	425mm pencil round	\$80.67
300041	Artista brackets (pryda) 195mm box of 20	\$146.18
300073	Artista brackets (pryda) 250mm box of 20	\$156.15
400568	Joiner Sleeve 345mm flush	\$26.10
400569	Joiner Sleeve 345mm Rebated	\$55.44
400609	Joiner Sleeve 425mm Flush	\$30.88
400610	Joiner Sleeve 425mm Rebated	\$65.60

15.5 GENERAL ACCESSORIES

GENERAL ACCESSORIES		
304491	James Hardie Base Coat 15kg bag	\$34.76
304493	James Hardie Top Coat 15kg pail	\$41.54
304490	James Hardie Base Coat 4kg pail	\$22.59
304492	James Hardie Top Coat 3kg pail	\$20.32
300550	Hydrexoxy 501 waterproof adhesive 2 litre	\$91.27
300753	JH Joint sealant cartridge 300ml	\$13.94
300636	Hardidrive screws 22mm Pkt 100	\$71.94
300637	Hardidrive screws 32mm Pkt 100	\$79.59
300635	Hardidrive screws 40mm Pkt 100	\$95.59
430052	JH Score and Snap knife	\$11.04
300653	Fibreshear heavy duty	\$842.96
303565	JH PVC 4.5mm cap mould 3m	\$2.28
303240	JH PVC internal angle 4.5mm 3m	\$5.28
303241	JH PVC external angle 4.5mm 3m	\$35.81
300871	JH PVC straight joint 4.5mm 2.4m	\$1.97
303561	JH PVC straight joint 4.5mm 3m	\$2.60
300838	JH PVC cap mould 6mm 3m	\$3.66
300845	JH PVC external angle 6mm 3m	\$8.77
300865	JH PVC Internal angle 6.0mm 3m	\$6.66
300853	JH PVC flashing mould 6mm 3m	\$10.48
300874	JH PVC straight joint 6mm 3m	\$4.39
300840	JH PVC Cellular angle 45mm x 45mm 3m	\$11.98
300660	Hardiblade Saw Blade 185mm	\$156.46